

OKI[®]
People to People Technology™



OKIPAGE™ 10e

LED PRINTER

User Manual



Every effort has been made to ensure that the information in this document is complete, accurate, and up-to-date. OKIDATA assumes no responsibility for the results of errors beyond its control. OKIDATA also cannot guarantee that changes in software and equipment made by other manufacturers and referred to in this guide will not affect the applicability of the information in it. Mention of software products manufactured by other companies does not necessarily constitute endorsement by OKIDATA.

Copyright 1999 by OKIDATA. All rights reserved.

First edition, July, 1999.

Written and produced by the OKIDATA Training and Publications Dept.

Please address any comments to:

Training and Publications Department
OKIDATA
2000 Bishops Gate Boulevard
Mount Laurel, New Jersey 08054-4620
<http://www.okidata.com>

OKIDATA is a registered trademark of Oki Electric Industry Company, Ltd.; Marque déposés de Oki Electric Industry Company, Ltd.; Marca Registrada, Oki Electric Industry Company, Ltd.

OKIPAGE is a trademark of OKI America, Inc.

ENERGY STAR is a trademark of the United States Environmental Protection Agency.

TrueType is a registered trademark of Apple Computer Company.

Hewlett-Packard, HP, and LaserJet are registered trademarks of Hewlett-Packard Company.

IBM is a registered trademark of International Business Machines Corp.

Microsoft and MS-DOS are registered trademarks and Windows is a registered trademark of Microsoft Corporation in the U. S. and other countries.

Intellifont is a registered trademark of Compugraphic Corporation.

Epson is a registered trademark of Seiko Epson Corp.

Contents

Features	5	Guidelines for Transparencies and Labels	20
Consumables	5	Using Recycled Print Media	20
Options	5	Printer Maintenance	22
Operating Your Printer	7	Replacing The Toner Cartridge	22
Using the Front Operator Panel	7	Replacing the Image Drum Cartridge	23
OKIPAGE 10e Front Operator Panel Reference	8	Cleaning the LED Array	24
OKIPAGE 10e Function Reference	12	Printing a Cleaning Page	26
Changing the Menu Settings	14	Problem Solving	28
Using the Printer Menu Setup	14	Clearing Paper Jams	28
Resetting the Menu	15	Print Quality Problems	32
Using Power Save to Minimize Warm-up Time	15	Software Problems	34
Printing the Menu	16	Hardware Problems	37
Maintenance Menu	16		
Using Special Print Media	16		
Printing a Special Document	17		
Enhancing Print Quality	18		
Printing Envelopes	18		
Selecting Envelopes	19		
Printing Transparencies and Adhesive Labels	19		

Service and Support	38
OKIDATA ONLINE	38
Your Dealer	39
The Okidata Customer Support Center	39
Okidata Customer Service Representatives	39
Purchasing Supplies	40
Warranty Service	40
OKIDATA SERVICE CENTERS	41
Index	43

Features

- Fast print speed: 10ppm with a 28 MHz RISC microprocessor
- Excellent print quality: 600 dpi class output
- Large paper capacity: 250 sheet paper tray and manual sheet/envelope feeder plus options for increasing paper capacity up to 850 sheets
- Memory: 4MB installed, expandable to 37MB
- Fonts: 35 PCL® fonts (Agfa), 10 True Type fonts, USPS Barcode font, OCR-A/B supported
- Emulations: Standard HP® LaserJet 5 (PCL5e), IBM® Proprinter III/Epson® FX (9-pin emulation)
- Printer drivers: Windows® 95, Windows 98, Windows 3.1, Windows NT 4.0
- Interface: IEEE 1284 bi-directional parallel interface
- On-screen status monitor and interactive software operator panel
- Energy Savings: Power is reduced when not printing
- 1 year overnight exchange warranty, 5 year warranty on the LED printhead (overnight exchange available in the US and Canada)

Consumables

Toner: 2,000 pages @ 5% print density (Type 5 Toner Cartridge Kit, Part# 52109001)

Drum: 20,000 pages with continuous printing (Type 5 Image Drum Cartridge Kit, Part# 40433305)

Options

- 500 sheet 2nd Paper Tray/Mechanism (Part# 70028701)
- 100 sheet/50 envelope Multi-purpose Feeder (Part# 70025101)
- 1 MB Memory Expansion Board with 2 expansion (SIMM) sockets (Part# 70033101)
- RS-232C Serial Interface Board with 2 expansion (SIMM) sockets (Part# 00025302)

To install the following options, a Memory Expansion Board or RS-232C Serial Interface Board must be installed.

- Flash Memory SIMM 4MB (Part# 70032601)
- Flash Memory SIMM 8MB (Part# 70033201)
- 4MB Memory SIMM Chip (Part# 70028801)
- 8MB Memory SIMM Chip (Part# 70033801)
- 16MB Memory SIMM Chip (Part# 70033901)
- 32MB Memory SIMM Chip (Part# 70034001)

Operating Your Printer

This section provides the following information:

- Using the front operator panel
- Setting printer features using the printer menu
- Using the printer software
- Using manual feed
- Printing envelopes
- Printing transparencies and labels
- Using recycled print media

Using the Front Operator Panel



Power Light





On

Printer is turned on.

Off

Printer is turned off.



OKIPAGE 10e Front Operator Panel Reference

Ready (Green)	Manual Feed (Amber)	Error (Red)	Meaning	User Options/Switch Function
				
on	off	off	Ready	<ul style="list-style-type: none"> • Quick press: takes printer off line
off	off	off	Off line	<ul style="list-style-type: none"> • Quick press: ready • 2 second press: print demo page and menu page • 5 second press: print cleaning page
blink	off	off	Processing/receiving data	<ul style="list-style-type: none"> • Quick press: pause printing (off line)

slow blink: one blink every 4 seconds

blink: one blink per second



fast blink: several blinks per second

Ready (Green)	Manual Feed (Amber)	Error (Red)	Meaning	User Options/Switch Function
				
slow blink	off	off	Printing paused	<ul style="list-style-type: none"> • Quick press: resume printing (on line) • 2 second press: print buffer contents • 5 second press: clear buffer and reset printer
off	off	blink	<ul style="list-style-type: none"> • Paper out • Paper jam (feed, eject and size error) • Cover open • Printing errors 	<ul style="list-style-type: none"> • Quick press: resume printing • Open cover, remove paper jam, close cover

slow blink: one blink every 4 seconds

blink: one blink per second



fast blink: several blinks per second

Ready (Green) 	Manual Feed (Amber) 	Error (Red) 	Meaning User Options/Switch Function	
blink or fast blink	blink or fast blink	blink or fast blink	Hardware error	Turn off and then re-power printer. If still not recovered, call service.
–	–	slow blink	<ul style="list-style-type: none"> • Warning • Change image drum • Toner low • Toner sensor 	Refer to on-screen status monitor

slow blink: one blink every 4 seconds

blink: one blink per second

fast blink: several blinks per second



Ready (Green)	Manual Feed (Amber)	Error (Red)	Meaning	User Options/Switch Function
				
off	blink	off	Ready for manual feed	Place sheet in manual feeder
Light on for a few seconds, then off, then blinks until ready	Light on for a few seconds, then off, then blinks until ready	Light on for a few seconds, then off, then blinks until ready	Powering-on	<ul style="list-style-type: none"> • 2 second press: set Menu 1 and Menu 2 to factory defaults

slow blink: one blink every 4 seconds

blink: one blink per second

fast blink: several blinks per second



OKIPAGE 10e Function Reference

User Options/Switch Function	Ready (Green) 	Manual Feed (Amber) 	Error (Red) 
Print demo page and menu page: 2 second press	off	off	off
Pause printing (off line): quick press	blink	off	off
Form feed (print buffer contents): 2 second press	slow blink	off	off

slow blink: one blink every 4 seconds

blink: one blink per second

fast blink: several blinks per second

User Options/Switch Function	Ready (Green)	Manual Feed (Amber)	Error (Red)
			
Resume printing (on line): quick press	off	off	blink
	slow blink	off	off
Set Menu 1 and Menu 2 to factory defaults: 2 second press	Light on for a few seconds, then off, then blinks until ready	Light on for a few seconds, then off, then blinks until ready	Light on for a few seconds, then off, then blinks until ready

slow blink: one blink every 4 seconds

blink: one blink per second

fast blink: several blinks per second

Changing the Menu Settings

The Menu provides a way to select printer operations and features using the printer's Printer Menu Settings.

- ! ***Operations and features set in your application software, will override Menu settings.***

Using the Printer Menu Setup

The printer menu setup is designed to perform as an interactive software "front panel" for accessing the printer's menu from your computer. To invoke the printer menu setup, open the status monitor, click the printer setup tab, then click the Printer Menu button. Click the Help button for an explanation of each feature.

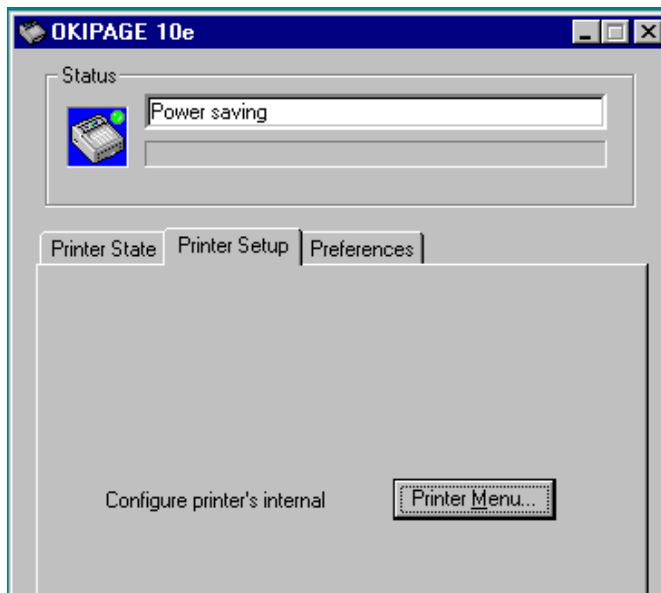

- ! ***Printer features set in your application software will override printer menu settings.***

Click on the appropriate tab to see the menu settings.

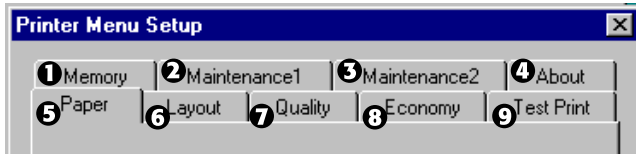

- (1) Set Raster Buffer, Font Protection.
- (2) Reset menu, drum count, print menu, interface.
- (3) Set display language, page placement, and print position.

! ***We suggest that only experienced users should change these settings.***

- (4) Access printer hardware and firmware information.
- (5) Select paper source, weight, size, transparencies.
- (6) Adjust lines per page, orientation, edit size, and select emulation (PCL, IBM®, EPSON®).
- (7) Set print output quality, darkness setting.
- (8) Set power save, toner save.
- (9) Print demo page, font page, menu settings, cleaning page.

Resetting the Menu

The menu can be reset to the factory (default) settings in the Printer Reset box of the Maintenance 1 Menu (See Maintenance Menu for information on using this feature).

Using Power Save to Minimize Warm-up Time

To minimize the printer's warm-up time between print jobs, disable the Power Save feature in the Printer Menu Setup:

- 1 In Windows 95, click **Start** and select **Programs**.
- 2 Choose **OKIPAGE 10e** and click **OKIPAGE 10e Status Monitor**.
The Status Monitor appears.
- 3 Select the Printer Setup tab and press **Printer Menu**.

4 In the Printer Menu Setup, select the Economy tab as shown below.

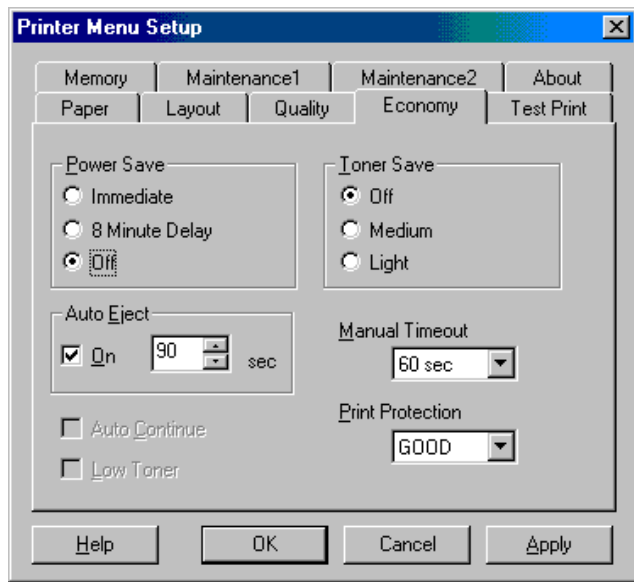

5 In the Power Save box, select **Off**.

6 Press **Apply** to finalize your change.

Printing the Menu

For a printout of all menu settings including default (factory) and user settings, firmware revisions, and total RAM capacity:

1 Enter the Test Print tab.

2 Click **Menu Print**.

The menu prints.

Maintenance Menu

The Maintenance Menu includes printer maintenance and operating functions.

Using Special Print Media

Use manual feed to print:

- Envelopes
- Labels
- Transparencies
- A special document not loaded in the paper tray, like a single letterhead page
- Paper heavier than 28 lbs.

Printing a Special Document

If you have plain paper loaded in the paper tray and you want to print one letterhead page or special document, do the following:

- 1 Set manual feed and paper size in your software.
- 2 Pull down the manual feed tray.

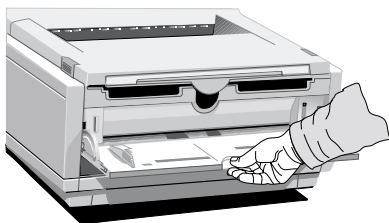
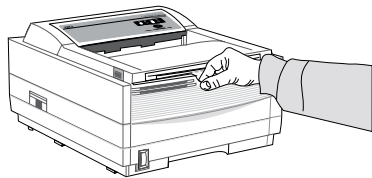

- 3 Adjust the paper guides to the width of the media.

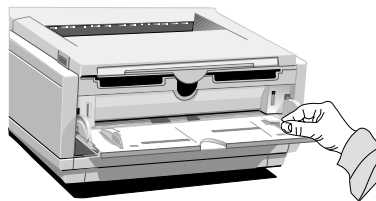

- 4 Insert the sheet (letterhead: top edge in first, facing up) until the printer grips it.

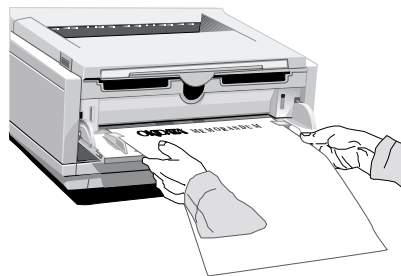

- 5 Issue the print command in your software.

Enhancing Print Quality

To enhance print quality when printing on different types of media, you can adjust the following settings using the printer Menu:

- Media Type - Adjust for paper thickness
- Print Mode - Select dots per inch
- Darkness Control - Adjust print density
- Toner Saving - Select proof copy quality to conserve toner

Printing Envelopes

- 1 Set envelope size and landscape orientation in your software.
- 2 Pull out the rear exit extender until it locks.

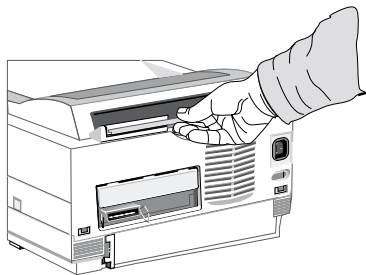

- 3 Lift out the support bar.

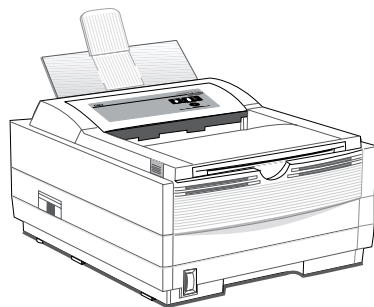

- 4 Pull the manual feed tray down.



5 Adjust the paper guides to the width of the media.

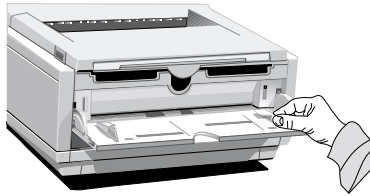

6 Insert the envelope – flap down and to the left – until the printer grips it.

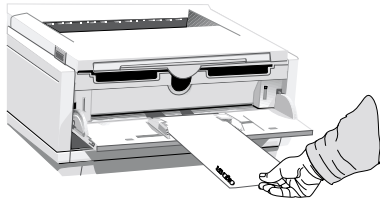

7 Issue the print command in your software.

Selecting Envelopes

- No windows, metal clasps, or snaps – they can damage the image drum.
- Paper no heavier than 28 lb.
- Sturdy construction.
- Smooth, even surface.
- Seams down the sides, not across the middle.
- Squared-off flaps that don't cover the print area.
- No self-sealing flaps.
- Always use rear output when printing envelopes.

Printing Transparencies and Adhesive Labels

1 Pull out the rear exit extender until it locks

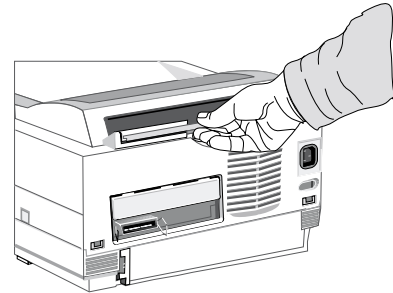

2 Lift out the support bar.

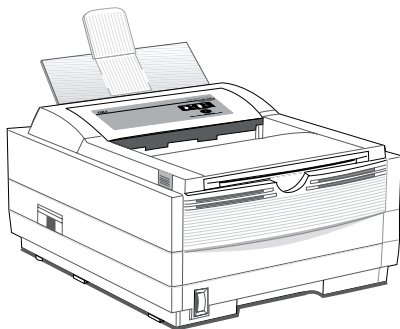

3 Insert the label sheet with print-side up.

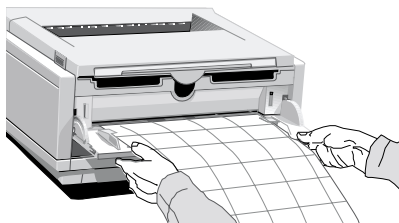

Guidelines for Transparencies and Labels

- Always use manual feed.
- Always use rear output when printing transparencies and adhesive labels.
- Should be specifically made for laser printers or photocopiers.
- Must be able to withstand heat of 200°C for 0.1 second.
- Labels should cover the entire carrier sheet-carrier and adhesive must not be exposed to any part of the printer.
- Use rear paper output – to reduce heat exposure and curling.

Using Recycled Print Media

Recycled paper should be restricted to 20% to 35% Post Consumer Content and not exceed 50%. Paper must be relatively stiff and have minimum edge curl. Paper should be white and bright for maximum contrast. The surface should be smooth, clean, and stable electrically and dimensionally.

*Recycled paper used by OKI printers must be specifically denoted by the paper manufacturer to be for laser printers, or laser guaranteed or compatible. **Using media outside these specifications may cause problems requiring service that will not be covered by OKIDATA warranty or service agreements.***

The following recycled paper has been tested and approved for use in OKI printers.

- Weyerhaeuser, Lynx Opaque, 20% PCW, 20lb., 28 lb. and Laser Copy, 20 lb.
- Union Camp Great White (Laser), 25% PCW, 20lb., 24lb.
- International Paper, Beckett Division, Enhanced Marble, 50% Recycled, 20% PCW, 24lb.
- International Paper, Hammermill Division, Savings DP, 20% PCW, 20 lb.
- Georgia Pacific, GeoCycle, 20% PCW, 20lb.
- James River, WordPro Laser, 20% PCW, 20lb., 24lb.
- Warren, SpectraTech, Gloss and Matte, 10% PCW, 28lb., 32lb.
- Cross Pointe, Worx, 50% Recycled, 20% PCW
- Strathmore, Script Bright White Wove, 50% Recycled

Printer Maintenance

This Section provides the following printer maintenance information:

- Replacing the Toner Cartridge
- Replacing the Image Drum
- Cleaning the LED Array
- Printing a Cleaning Page

Replacing The Toner Cartridge

Replace the toner cartridge after TONER LOW displays on the printer's front operator panel, or on your screen in the Status Monitor if you have installed the printer software. After TONER LOW displays, the printer will print approximately 100 more sheets, then display TONER EMPTY and stop printing. Printing will resume when a new toner cartridge is installed.

- 1 You will need a new toner cartridge (OKIPAGE 10 and 12 Series Type 5 Toner Kit, Part# 52109001).
- 2 Open the printer cover.
- 3 Grasp the lock lever and pull towards the front of the printer to unlock the cartridge. Carefully lift out toner cartridge and discard the used toner cartridge.

! ***Loose toner powder may exist. Be careful.***

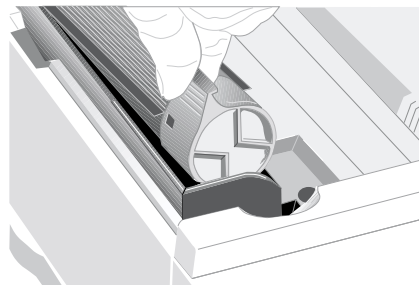

4 To install a new toner cartridge, follow the instructions included in the toner cartridge kit.

5 Be sure to clean the LED array.

- ! ***Drum and Toner are consumables and as such are subject to a 90-day warranty on workmanship.***

Toner Cartridge Life

How long your toner cartridge lasts depends on the print density, the percentage of the page that prints black.

- A typical letter has 3% to 5% print density, graphics usually have higher density.
- Higher print density means toner is used up faster.
- At 5% print density, a toner cartridge will print an average of 2,000 pages. Remember, this is only an average. Actual results may vary.

The first toner cartridge in your new printer has to fill the drum reservoir and saturate the developing roller with toner. It's normal that the first cartridge will produce about 1,000 pages.

Replacing the Image Drum Cartridge

When the image drum reaches 90% of its life, the CHANGE DRUM message will display on your screen in the Status Monitor if you have installed the printer software. Change the image drum cartridge when the print becomes faint or begins to deteriorate. It's a good idea to keep a new cartridge on hand.

- 1 You will need a new image drum cartridge (OKIPAGE 10 and 12 Series Type 5 Image Drum Cartridge Kit, Part# 40433305) and a new toner cartridge (OKIPAGE 10 and 12 Series Type 5 Toner Kit, Part# 52109001).
- 2 Open the printer cover.

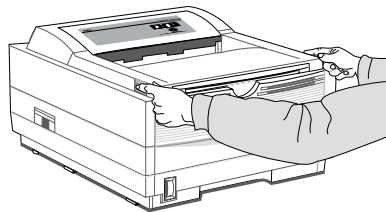

- 3 Lift out the used image drum cartridge with toner cartridge installed. Dispose of properly with the black plastic bag included with the new image drum kit.

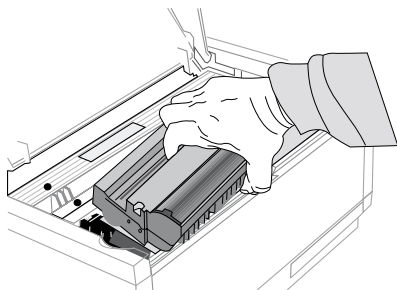

- 4 Remove the new image drum cartridge from the package. To install the new image drum cartridge, follow the installation instructions included in the replacement kit.
- 5 Be sure to reset the drum counter. See “Using the

Printer Menu Setup” above for details.

Image Drum Cartridge Life

The life of the image drum depends on a number of factors, including the operating temperature, humidity, the type of paper you use, and the number of pages per job. Each time you print or power on/off, the drum has to rotate to start up and to wind down. As a result, frequent one-page print jobs will wear down your drum more quickly than multiple-page print jobs. The image drum cartridge should last up to 10,000 pages at 1 page per job, or 20,000 pages at 3 pages per job (continuous printing). These numbers are approximate, since you won't print the same number of pages each time, and environmental conditions and paper type used may vary.

Cleaning the LED Array

Clean the LED array each time you install a new toner cartridge, or if you have faded vertical areas or light printing down a page.

The LED array is on the underside of the printer cover. Wipe it gently with the cleaning pad that is included in the toner cartridge kit. You can also use a clean, soft cloth with a small amount of rubbing alcohol on it.

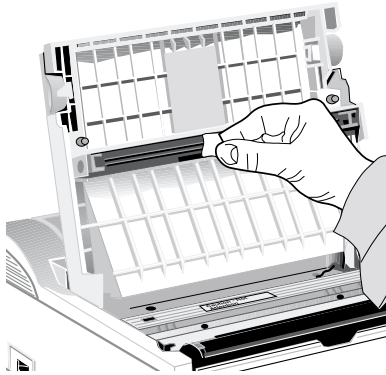

Printing a Cleaning Page

The cleaning page process removes residual impurities from printing surfaces. Printing a cleaning page helps reduce print quality problems, such as repeated marks, blotches, and shaded areas.

From the status monitor:

- 1 Click the Printer Menu button on the status monitor Controls tab.

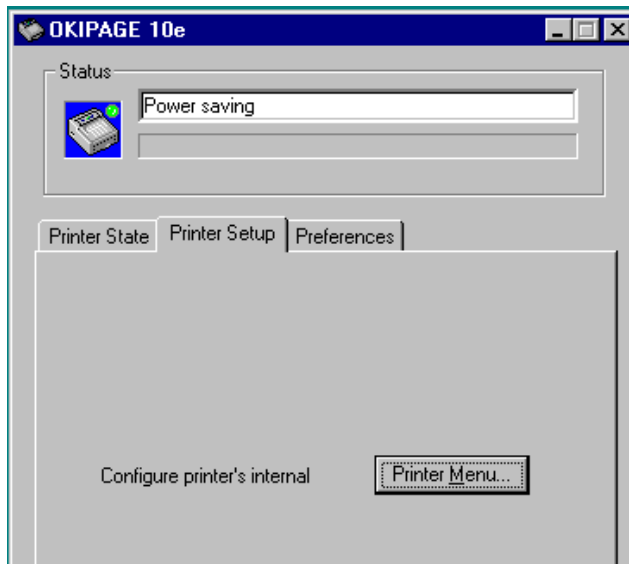

2 Click the Test Print tab.

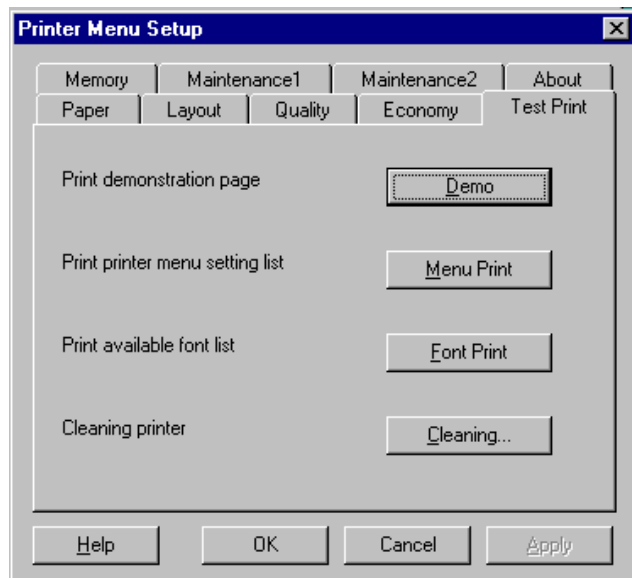

3 Click the **Cleaning...** button. Follow the on-screen instructions.

Problem Solving

This Section provides the following problem solving information:

- Clearing Paper Jams
- Print Quality Problems
- Software Problems
- Hardware Problems

Clearing Paper Jams

- ! *The error light on the printer's operator panel blinks (one blink per second) whenever there is a paper jam of any kind.*

To reduce paper jams:

- Do not fill tray above Paper Full mark.
 - Use only recommended paper weight
 - Tray: 16 to 28 lb. (60 to 105 g/m²)
 - Manual feed: 16 to 32 lb (60 to 120.5 g/m²)
 - Do not open the cover, or remove the paper tray during a print job.
 - Do not switch paper exit paths while printing.
 - Use paper that is smooth and of high quality.
 - Store paper in its ream wrapper until you are ready to use it, and keep it away from moisture or other conditions that can cause it to wrinkle or curl.
 - Avoid printing on both sides of the paper for more than a few pages, or preprinted documents that have been in a photocopier.
 - Try paper before you buy in quantity.
- If a paper jam message displays, remove the jam using the instructions that follow.

TRAY “n” INPUT JAM

- ! *“n” indicates the tray number in which the jam occurred (standard configuration is tray 1).*
- 1 Slide the paper tray out of the printer.

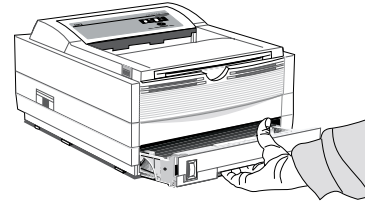

- 2 Remove the sheet that did not feed.

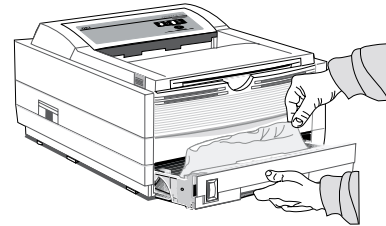

- 3 Check the remaining sheets to make sure they're not wrinkled or stuck together. Replace the tray.
- 4 Open and close the cover to clear the display message.

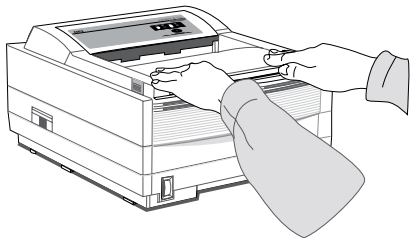

TRAY "n" FEED JAM or PAPER EXIT JAM (top bin)

Displays when paper exits to the top bin

- 1 Open the cover. Lift out the image drum. **Be careful: the fuser unit at the back of the printer is hot!**

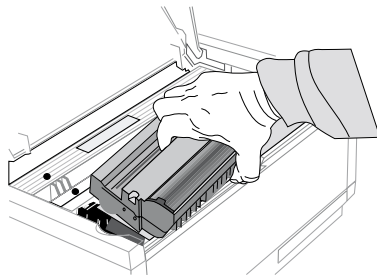

- 2 Remove the jammed paper.

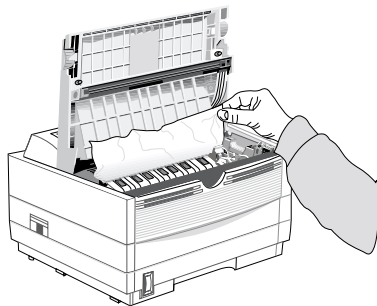

3 Replace the image drum. Close the cover.

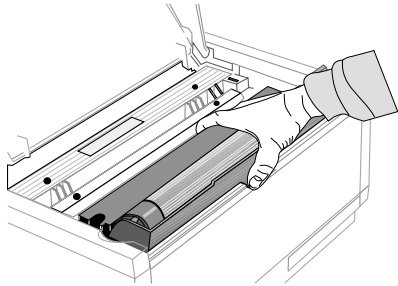

PAPER EXIT JAM (rear tray)

Displays if paper exits to rear exit tray

1 Lift the top cover.

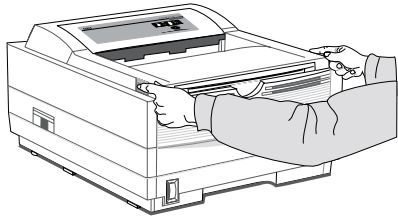

2 Pull the jammed paper out from the back of the printer. Pulling from the front may damage the printer.

3 Remove the image drum and look to make sure the paper is cleared and no pieces are left.

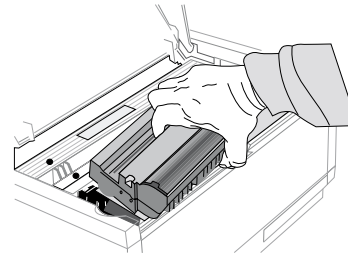

4 Replace the image drum and close the cover.

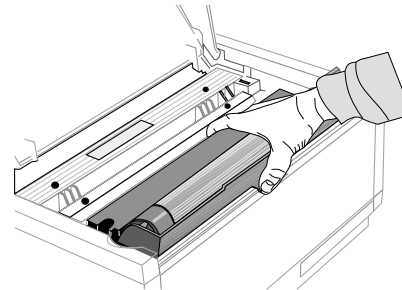

Print Quality Problems

Before consulting a service representative regarding a print quality problem, check the table below to see if there is a solution, or something you might have overlooked.

Symptom: Blank sheets printed.

Problem: Image drum cartridge not properly installed.

Solution: Reinstall image drum cartridge.

Problem: Empty or missing toner cartridge.

Solution: Install new toner cartridge.

Symptom: Entire page prints faintly.

Problem: Empty toner cartridge. Pages get fainter when toner is low.

Solution: Install new toner cartridge.

Problem: LED array is dirty.

Solution: Clean LED array. (See Printer Maintenance section.)

Symptom: Page has gray background.

Problem: Static electricity, generally from dry, cotton fiber papers, causes toner to stick to background.

Solution: Change papers to an acceptable laser bond or use a humidifier.

Symptom: Vertical white streaking or faint areas on page.

Problem: Toner is low and does not distribute properly or the drum is worn out.

Solution: Replace toner cartridge. Check drum and replace the drum, if necessary. Contact service.

Problem: LED array dirty.

Solution: Clean LED array.

Symptom: Vertical black lines.

Problem: Scratched image drum.

Solution: Replace the image drum cartridge.

Problem: Hardware problem.

Solution: Contact service.

Symptom: Fuzzy print
Problem: Dirty LED array.
Solution: Clean LED array.

Symptom: Distorted print
Problem: Paper path, lamp assembly, or fusing unit problem.
Solution: Generate Cleaning Page. Contact service.

Symptom: Faded print after installation.
Problem: Toner cartridge is not correctly installed.
Solution: Install toner cartridge correctly.

Symptom: Smearred or blotched print.
Problem: Dirty or defective fuser assembly or other hardware problem.
Solution: Generate Cleaning Page. Contact service.

Symptom: Printed page is light or blurred.
Problem: Is toner low?
Solution: Replace toner cartridge.
Problem: Is paper meant for laser printers?
Solution: Use recommended paper.
Problem: LED array is dirty.
Solution: Clean LED array.

Symptom: Bold characters and dark lines are smeared.
Problem: Toner is low.
Solution: Install new toner cartridge.

Symptom: Print is darker than usual.
Problem: Darkness setting is too high.
Solution: Change darkness setting in the printer menu.

Symptom: Pages curl excessively

Problem: Printing on wrong side of paper. High humidity.

Solution: Turn paper over in tray. Note arrow on paper package. Install paper print side down in tray.

Problem: Moisture in paper. Improper storage.

Solution: Avoid storing paper in areas of excessive temperature changes and humidity.

Problem: High Humidity.

Solution: Recommended operating humidity: 20-80%

Software Problems

Software controls printing features. Make sure you have selected the correct printer driver in your software. See your software application documentation for more information.

Symptom: Status Monitor displays Checking Status indefinitely. The Printer Menu button is greyed and not active.

Problem: Bi-directional communication is not being achieved through the printer port.

Solution: Check cable for IEEE 1284. Verify PC is set for bi-directional printing. Remove any previously-installed printer software that may cause conflict.

Symptom: Blank pages appear between printed pages.

Problem: Number of lines per page in software is not equal to number of lines per page of printer.

Solution: Many software packages assume 66 lines per page; your printer default is 60. Adjust software accordingly, or set LINES/Pg in Menu 1 to equal lines per page in software.

Symptom: Cannot get justified right margin with a proportionally spaced font.

Problem: Right justification with proportional fonts is a software feature.

Solution: Check your software manual to see if this feature is supported.

Symptom: Control codes not operating correctly.

Problem: Incorrectly entered control codes.

Solution: Check for confusion of letter *I* with number 1, letter *O* with number 0; make sure you are using upper/lower case correctly; make sure font is specified correctly and is available.

Symptom: Data is sent to printer, but nothing happens. ON-LINE message appears.

Problem: Wrong interface cable.

Solution: Use correct cable. If optional Serial I/F is installed, make sure RS232C Serial is selected in the Level 1 menu and RS232C Serial settings in Level 2 menu are correct.

Symptom: Last page of document not printed.

Problem: No form feed provided at end of document.

Solution: Press the ON-LINE button to take the printer off-line, then press the FORM FEED button to eject the final page or send the form feed code (decimal character 12).

Symptom: First line on page won't print.

Problem: Tops of letters extend into unprintable area, so none of them print.

Solution: Set your software to print within the printable area.

Symptom: Parts of control codes are printed at the beginning of documents.

Problem: Command sent is not a true printer command, generally because the ESC character was not sent.

Solution: Before sending control codes through an application, make sure the ESC character can be entered, and is entered properly.

Symptom: Parts of documents are missing at the edges of the printed sheet.

Problem: Software is attempting to print beyond the printer's maximum image area.

Solution: Adjust software page margins to printer's maximum margins (8" X 10" for standard sheets).

Symptom: Print job started with italics, changed to bold, but italics still output.

Problem: Font selection is by priority, and italic is "higher" than bold.

Solution: Turn italics off before turning bold on.

Symptom: Printer ignores control codes sent prior to printing a document.

Problem: The application software automatically sends a reset command before printing.

Solution: Embed the control codes in the text to be printed.

Symptom: "Garbage" prints out.

Problem: Incorrect driver is installed.

Solution: Install an appropriate driver.

Symptom: Printer's output is below rated speed.

Problem: Delays are caused by software formatting routines, graphics downloads, and other application specific factors.

Solution: For maximum speed, output plain text.

Symptom: Size of top margin increases with each page printed.

Problem: "Creeping text." Number of lines per page in software is not equal to number of lines per page of printer.

Solution: Many software packages assume 66 lines per page, but your printer's default is 60. Adjust software accordingly, or set LINES/ Pg in Menu 1 to equal lines per page in software.

Problem: In Epson FX Emulation, when command for 66 lines is sent to the printer, printer prints only 64 lines on a page, loses the 65 and 66 line and prints 67th line on the second page.

Solution: Set line spacing to 35/216 with a software command ESC "3" Pn (Pn=number of 216ths). Then send the command to set the page length to 66 lines per page, ESC C Pn (Pn = number of lines per page).

Symptom: Strange symbols appear during normal printing.

Problem: Wrong symbol set.

Solution: Make sure the symbol set selected corresponds to symbol set resident, in font card, or in soft font.

Hardware Problems

Symptom: Graphic image prints partly on one page, partly on the next.

Problem: Insufficient printer memory for this image at this resolution.

Solution: Change the resolution, reduce the image size, or install more memory in your printer.

Symptom: Nothing happens, but printer indicates it is ready to receive data.

Problem: Configuration error.

Solution: Check cable connection; if serial, make sure appropriate MODE command has been used (PC). If more than one printer is available, make sure your printer has been selected. Make sure your printer is on-line.

Symptom: "Garbage" prints.

Problem: Incorrect cable configuration. (Also, see "Software Problems.")

Solution: Check cable configuration, continuity, and length.

Symptom: Printer freezes or displays error message when computer is rebooted.

Problem: Booting the computer while the printer is on can cause a communications error.

Solution: Take printer off-line before rebooting computer.

Problem: Gases are given off by forms or adhesives passing through the hot fusing unit.

Solution: Make sure the forms you use can withstand heating, and provide adequate ventilation.

Service and Support

This information is valid for the United States and Canada only.

This section provides the following service and support information:

- OKI Online
- Your Dealer
- The Okidata Customer Support Center
- Okidata Customer Service Representatives
- Purchasing Supplies
- Warranty Service
- Okidata Service Centers

If you can't solve your printer problem after reading this manual, contact these sources for service or support.

OKIDATA ONLINE

Visit the OKIDATA Web Site at

<http://www.okidata.com>

for the latest information on:

- Software drivers
- Product guides
- Customer support
- Corporate information
- Dealers
- Documentation

Your Dealer

Consult the store where you purchased your printer, or call 1-800-OKIDATA for the location of the nearest authorized Okidata service dealer. Have your ZIP code ready.

- Proof of purchase is required for warranty work. Be sure to retain your purchase documents.
- Prices and minimum charges may vary.

The Okidata Customer Support Center

For customer service, call 1-800-OKIDATA. The Okidata Information System Automated Attendant is available 24 hours a day, 7 days a week. The system can provide immediate assistance with:

- Basic printer operating procedures
- Sales and service referrals
- Parts and consumable referrals
- Product information

Okidata Customer Service Representatives

Agents are available 24 hours a day, 7 days a week. Please be sure that you are calling from a telephone close to your printer, so you can describe your problem accurately. Our customer service representative are trained on all current OKI products. They can answer your questions regarding:

- Installation of your printer
- Determination of printer issues
- Consumer relations
- Availability and installation of printer drivers. (*CSRs are not trained to provide assistance with the use of commercial software packages. Please consult your software user's manual for times and availability of their support.*)

Purchasing Supplies

Before you order, know your printer model number (see the front of the printer) and have the correct part number and description of the item.

Ways to Purchase

- Consult the dealer where you purchased your printer.
- Consult an Okidata authorized sales or service dealer.
- Call 1-800-OKIDATA for the nearest Authorized Sales and Service location. Have your ZIP code ready for our Customer Support Representatives.
- Check office supply catalogs or your local stationery store. Most carry OKI brand supplies.

Warranty Service

Your printer is warranted for one year from date of purchase except for the printhead (LED imaging array), which is warranted for a period of five years from date of purchase. If your printer hardware should fail during the warranty period, you have the option of returning it, shipped prepaid to OKIDATA or an authorized service center, or using the overnight exchange procedure (U.S. and Canada only). See the list of OKIDATA Service Centers or call 1-800-OKIDATA for the location of the nearest authorized Okidata service dealer. Have your ZIP code ready. See Limited Warranty and Overnight Exchange in this section for more information.

OKIDATA SERVICE CENTERS

If you need to ship your printer to a service center, replace it in the original packing materials. If the original packaging is not available, contact your dealer or 1-800-OKIDATA for shipping instructions.

For out-of-warranty repairs, allow 30 days for round trip shipping and repair. Before shipping your printer, call for a return authorization number (RA).

Okidata Service Center Locations:

Service & Repair: USA

Okidata

2020 Bishops Gate Blvd.
Mt. Laurel, NJ 08054

Phone: 800-654-3282
Fax: 609-222-5247

Service & Repair: Canada

Okidata

2735 Matheson Blvd. East, Unit 1
Mississauga, Ontario
Canada L4W 4M8

Phone: 800-654-3282
Fax: 905-238-4427

Service & Repair: Latin America

General Information (Spanish Only): 1-609-222-5276

Argentina

Megatech

Lavalle 1524
1048 Buenos Aires, Argentina

Phone/Fax: (541) 371-4123
[Touch-Tone required]

Brazil

Oki Data do Brasil, Ltda.

Av. Leonardo da Vinci, 1178/1182
Jabaquara
Sao Paulo, Brazil

Phone: 55-11-5011-1518
Fax: 55-11-5012-0267

Chile

Teknos Comunicaciones

Santa Elena 2222

Santiago, Chile

Phone: 56 (2) 555-5530

Fax: 56 (2) 550-2399

Colombia

Impact

Calle 93 Bis No 19-50

Ofic 103-105

Bogota, Colombia

Phone: 571-616-1385

Fax: 571-616-1386

Mexico

Oki Data de Mexico, S.A. de C.V.

Av. Insurgentes 1700 – 7 Piso

Col. Florida 01030

Phone: (525) 661-6860

Fax: (525) 661-5861

Peru

Teknos Comunicaciones

Los Sauces 325

San Isidro, Lima 27, Peru

Phone: 511-222-1818

Fax: 511-221-5404

Venezuela

IBM

Av. Ernesto Blohm

Edif. IBM, Chuao.

Caracas, Venezuela

Phone: 582-908-8111

Fax: 582-908-8895



Index

A

Adhesive Labels 19

C

CHANGE DRUM 23

Cleaning Page 26

Cleaning the LED Array 24

Consumables 5

 image drum 5

 toner 5

Customer Information Center 39

Customer Service Representatives 39

Customer Support Center 39

D

drivers, printer 5

E

emulations 5

Energy Savings 5

Envelopes 18

F

Fonts 5

 OCR-A/B 5

 True Type 5

Front Operator Panel 7

I

Image Drum Cartridge, replacing 23

Interface 5

L

Labels 19
LED Array, cleaning 24

M

Maintenance Menu 16
Memory 5
Menu
 printing 16
 resetting 15
 using 14

O

OKIDATA Online 38
operator panel 5
operator panel, on-screen 14
Options 5

P

paper capacity 5
Paper Jam
 exit jam (rear tray) 31
 exit jam (top bin) 30
 feed jam 30
Paper Jams
 clearing 28
 input jam 29
print quality 5
Print Quality Problems 32
print speed 5
printer drivers 5
printing
 cleaning page 26
 enhancing quality 18
 envelopes 18
 labels, adhesive 19
 menu 16
 special document 17
 transparencies 19
Printing Envelopes 18
Purchasing Supplies 40

S

- Service and Support 38
 - Customer Information Center 39
 - Customer Service Representatives 39
 - Dealers 39
 - OKIDATA Online 38
 - regional service centers 41
 - Warranty Service 40
 - Web Site 38
- Status Monitor 22, 23
- status monitor 5, 26
- Supplies, purchasing 40

T

- Toner Cartridge, replacing 22
- Transparencies 19

U

- USPS Barcode font 5

W

- Web Site 38

